

CABLE TIES

Plastic type

Wide ranging lineup of cable ties

Bundling and securing wire/cable bundles

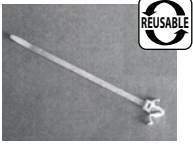

P93
RE-USE BAND

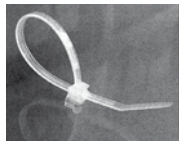

P94
SNAP BAND

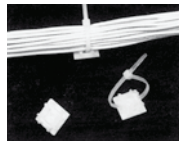

P94
CABLE TIE MOUNT



P95
CABLE TIE MOUNT



P95
CABLE TIE MOUNT



P95
CABLE TIE MOUNT

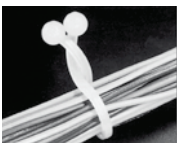

P96
OMEGA LOCK

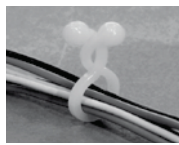

P96
WIRE LOCK

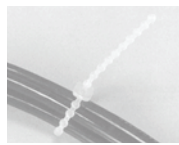

P97
BEADS BAND



P98
BUNDLE BAND



P99
SOFT TIE

Bundling and securing wire/ cable bundles (SK Binder)

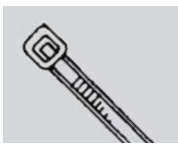

P100
Standard type

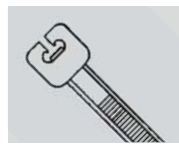

P100
Open head type

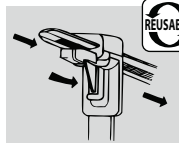

P101
Reusable type



P101
Screw mount type

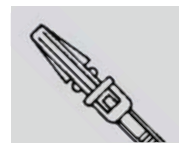

P101
Push mount type

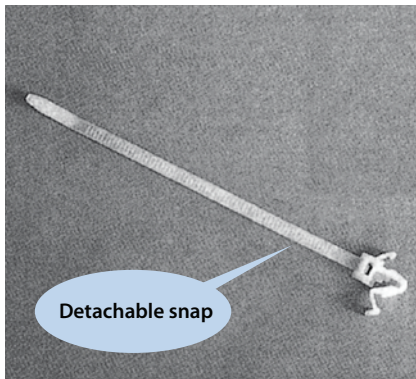

Features

- Detachable snap and un-lockable band allow easy maintenance and disassembling.



Reusable Snap Mounting



Round hole

Material

- ABS (Color: Natural, Black*)

UL94 V-0 (V-2*)

* RSG-190E-BK is available in black and UL94V-2 material only.

RSG-100V0,130V0

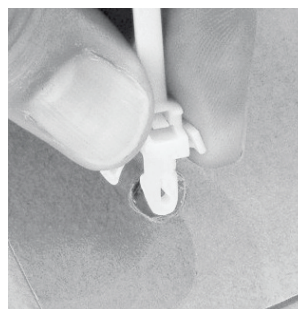
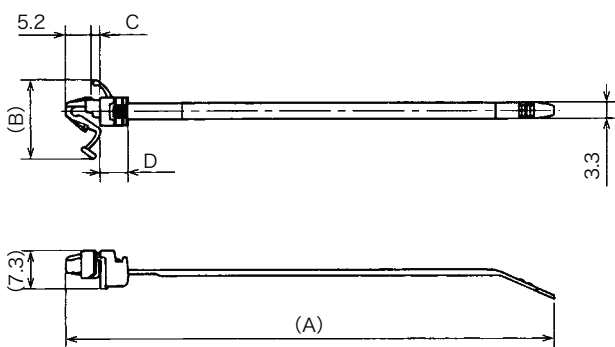

Push and remove

RSG-190E-BK

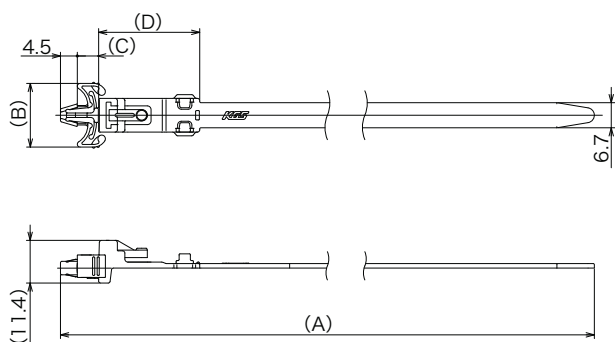

Unused part of band can be held with the hook

Snap removal

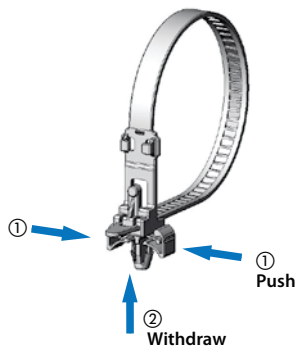

Bundle release

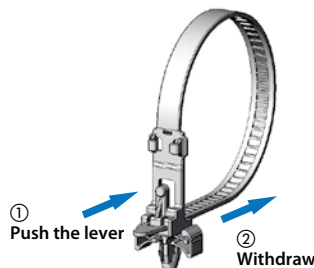

Holding remaining part

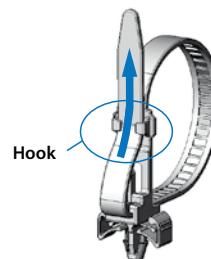

Part No.	(A)	(B)	(C)	(D)	Mounting hole size	Panel thickness	Bundle diameter	Std. Package
RSG-100 V0	100.0	16.2	1.8	5.9	φ4.8 ^{+0.2}	0.5~1.6	φ1~20	500 pcs.
RSG-130-V0	133.5	17.9	2.7	6.2		0.6~2.4	φ1~24	
RSG-190E-BK	195.2	17.0	5.7	27.0		0.5~2.3	φ10~47	100 pcs.



UL ...UL1565 recognized product

(Unit: mm)

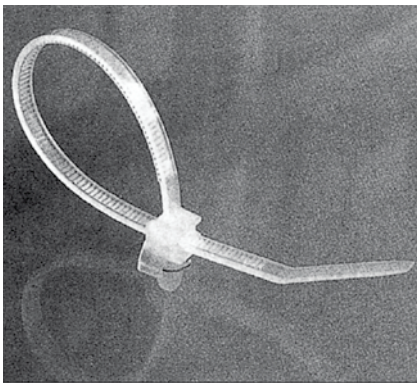

Features

- Simultaneous securing and bundling of cables.



Material

- Nylon 66 (Color: Natural)

UL94 V-2 (V-0*)

* For V0 type, "V0" is added to the end of the part No.
(With regard to lot size and lead time, please contact us.)

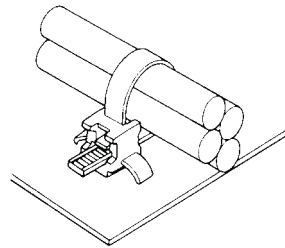
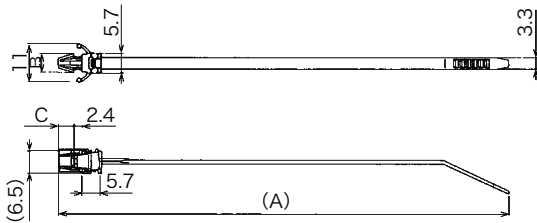

Part No.	(A)	B	C	Mounting hole size	Panel thickness	Bundle diameter	Std. Package
SG-110	110	6.2	3.5	$\phi 4.8^{+0.2}_0$	0.5~2.0	$\phi 1\sim 20$	500 pcs.
SG-130	132	5.4	4.5	$\phi 4.0^{+0.2}_0$		$\phi 1\sim 24$	



UL...UL1565 recognized product

(Unit: mm)

CABLE TIE MOUNT / TMS

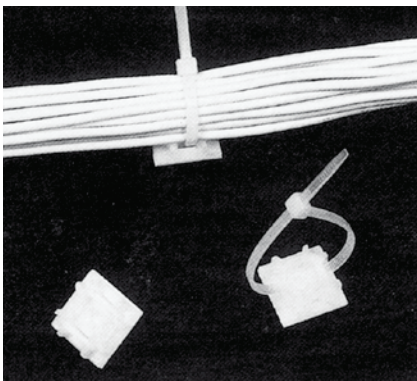

Features

- Can be mounted with either screw or adhesive tape.
- Cable tie can enter from any of four directions.

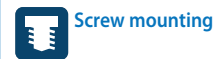
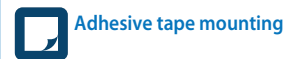

(Screw type has "No adhesive backing" at the end of Part No.)

Material

- Nylon 66 (Color: Natural)

UL94 V-2

(Resin portion of the body)

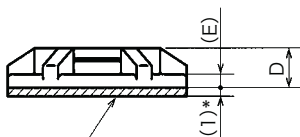
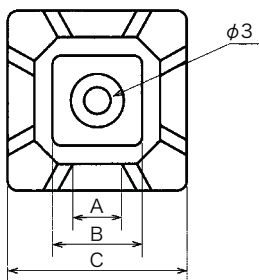
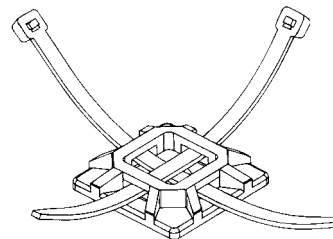

Double sided adhesive tape (TMS-20 · TMS-30)

* 1.3mm for TMS-30.

Part No.	A	B	C	D	(E)	Screw (Small flat head screw)	Cable tie	Std. Package
TMS-20	5.2	10.0	20.0	4.5	1.5	—	Width Max 5.0	200 pcs.
TMS-20 No adhesive backing						M2.5	Thickness Max. 1.5	
A TMS-30	8.2	12.0	30.0	6.0	2.0	—	Width Max 8.0	
TMS-30 No adhesive backing						M2.5~M3	Thickness Max. 2.0	

(Unit: mm)

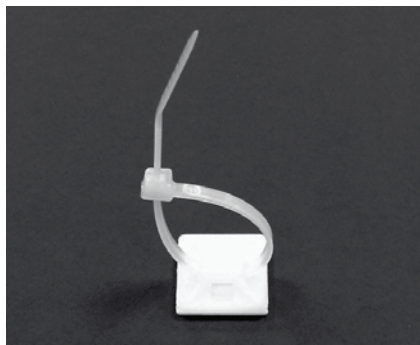

DN

Features

- Can be mounted with adhesive tape

Material

- Nylon 66 (Color: Natural)

UL94 V-2 (V-0*)

* For V0 type, "V0" is added to the end of the part No.
(With regard to lot size and lead time, please contact us.)

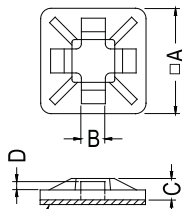

Std. Package: 1000 pcs.

Part No.	A	B	C	D
DN-13	13	3.2	3.2	1.3

(Unit: mm)

3M DOUBLE ADHESIVE TAPE
(THICKNESS 1.1mm)

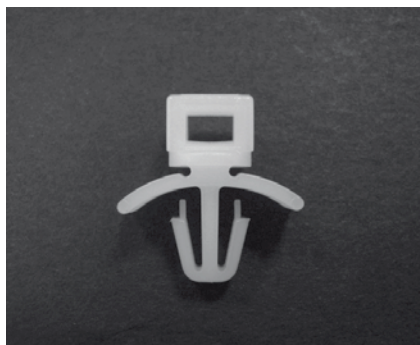

DDNF-1

Features

- Can be mounted with snap on PCB



Snap Mounting

Material

- Nylon 66 (Color: Natural)

UL94 V-2 (V-0*)

* For V0 type, "V0" is added to the end of the part No.
(With regard to lot size and lead time, please contact us.)



Round hole

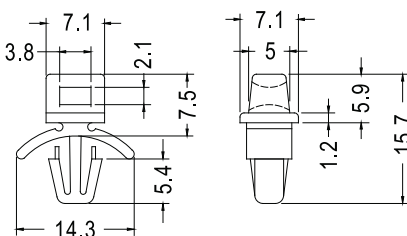

Std. Package: 1000 pcs.

CHASSIS Ø4.8
THICKNESS 0.8~2.0

(Unit: mm)



DDNX-1

Features

- Can be mounted with snap on PCB

Material

- Nylon 66 (Color: Natural)

UL94 V-2 (V-0*)

* For V0 type, "V0" is added to the end of the part No.
(With regard to lot size and lead time, please contact us.)

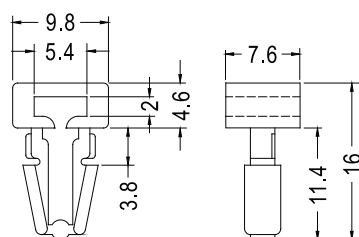

Std. Package: 1000 pcs.

PANEL HOLE DIA 6.4
PANEL THICKNESS 3.17 MAX

(Unit: mm)

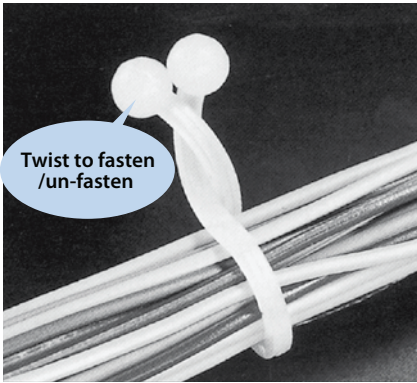

Features

- Cost saving and easy locking /un-locking.

Material

- Nylon 66 (Color: Natural*)

UL94 V-2

* Color of OLS -150 BK is black.

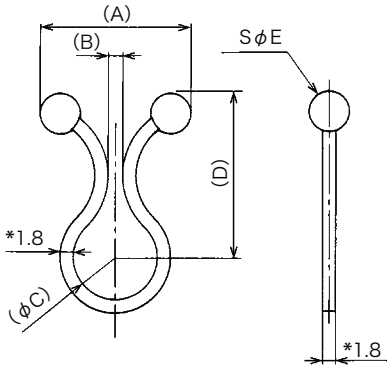

* 1.9 mm for OLS-115 and OLS-150BK.

Part No.	(A)	(B)	(φC)	(D)	SφE	Std. Package
OLS-50	15.0	1.0	5.2	15.5	5.0	500 pcs.
OLS-80	20.2	1.1	8.2	20.1	5.7	
OLS-115	20.6	2.0	11.5	22.4	5.5	
OLS-150BK	21.0	2.0	15.0	23.75		

(Unit: mm)

WIRE LOCK / UM

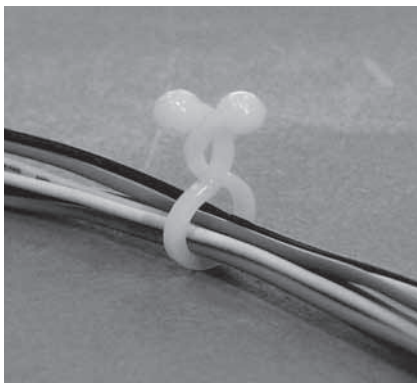

Features

- Cost saving and easy locking/un-locking

Material

- Nylon 66 (Color: Natural)

UL94 V-2 (V-0*)

* For V0 type, "V0" is added to the end of the part No.
(With regard to lot size and lead time, please contact us.)

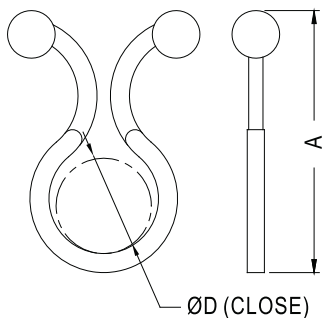

Part No.	A	D	CLOSED (D)	Std. Package
UM-5	35.0	18.8	17.2	500
UM-6	41.4	25.8	24.2	
UM-7	42.0	22.0	19.5	
UM-8	16.5	5.6	5.0	
UM-9	30.0	11.0	9.7	
UM-13	32.5	13.2	11.5	
UM-28	55.5	29.0	26.8	

(Unit: mm)

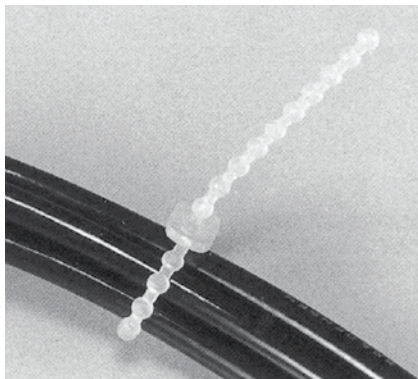

Features

- Reusable beaded tie, easy fastening and releasing.

Material

- Refer to the table below since the material varies for each Part No.
Only nylon type is UL94 V-2 recognized.

UL94 V-2

How to handle

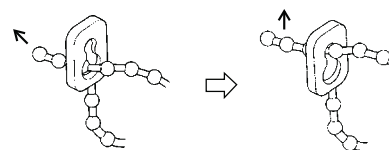

NS-80

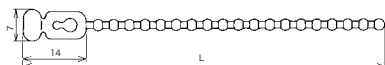

N-108, P-108

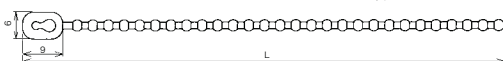

N-255, P-255

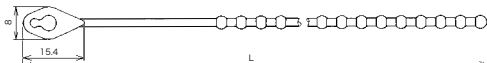

Part No.	L	Material	Bundle diameter	Color	Std. Package
NS-80	81	Nylon 66	φ 2~26	Natural	1,000 pcs.
N-108	108	Nylon 6		Black	500 pcs.
N-255	255		Polyethylene	φ 12~73	Natural
P-108	108	500 pcs.			
P-255	255	Polypropylene	φ 12~73		1,000 pcs.

(Unit: mm)



Features

- Can be cut to required length out of a rolled band. Economical and minimizes waste.
- Available in four band widths, as well as four kinds of mounting accessories.

Material

- Nylon 6* (Color: Black)

* Mount B is made of PP (Color: Black).

KB-07 ~16

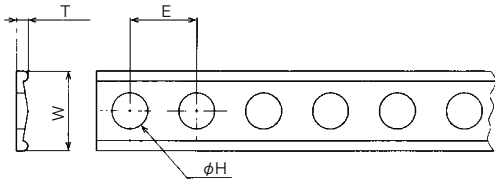

Part No.	W	T	E	φH	Stopper and Mount	Std. Package
KB-07 Black	7.1	0.9	6.0	3.2	Snap button, Mount A	2m×50 pcs.
KB-09 Black	9.5	1.3	8.0	4.3	Buckle, Snap button, Mount A, Mount B	
KB-13 Black	13.0	1.6	10.0	5.5	Snap button, Mount A	5m×5 pcs.
KB-16 Black	16.0	1.9	12.5	6.5	Buckle	5m×10 pcs.

(Unit: mm)

Stopper and Mounts for KB

■ Buckle (Stopper) / For KB-09

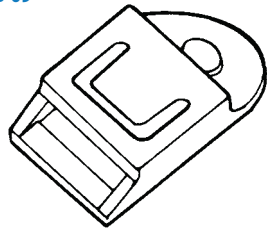

Elastic material provides secure locking using the top and bottom buttons.

Std. Package:100pcs.

■ Snap button (Stopper) / For KB-07 · KB-09 · KB-13

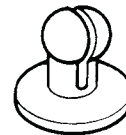

Easy and fast mount/dismounting. One end of the band is fixed on the button, and a wire/cable bundle is secured by snapping the hole into the button.

Std. Package:100pcs.

■ Mount A / For KB-07 · KB-09 · KB-13

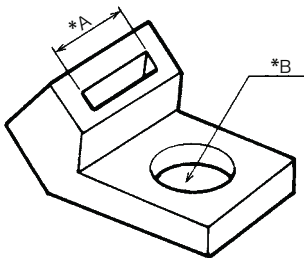

Secures bundled wires/cables on a panel or wall.

- * Dimension A
KB-07 8.5 mm
KB-09 9.8 mm
KB-13 16 mm

- * Dimension B
KB-07 φ4.2 mm
KB-09 φ5 mm
KB-13 φ5.2 mm

Std. Package:100pcs.

■ Mount B / For KB-09

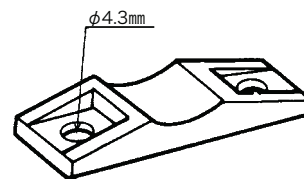

Secures bundled wires/cables on a panel or wall.

Std. Package:100pcs.

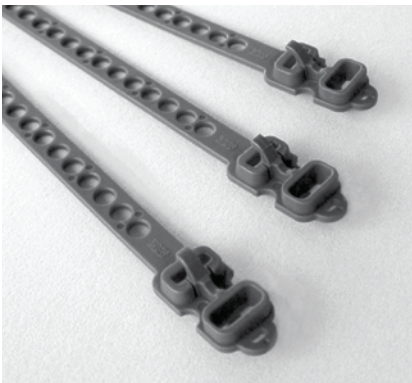

Features

- Elastic material secures bundle wires/cables softly.
- Easy bundling and releasing. Double loop fastening is possible.
- Applicable to bundle diameters 3-45mm.

Material

- Polyester elastomer (Color: Dark Blue, Black*)

UL94 HB

* Black component is only made to order.

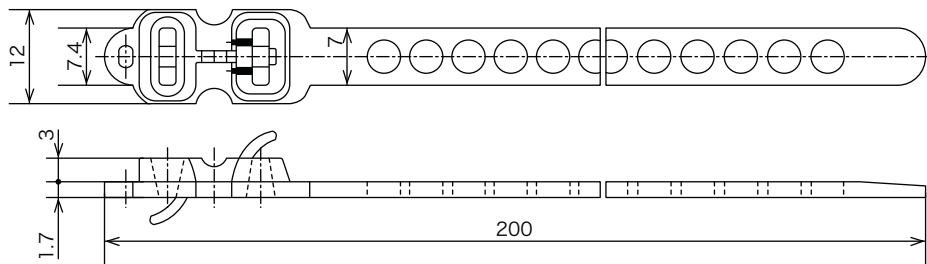

(Unit: mm)

Std. Package: Dark blue: 1000 pcs.
Std. Package: Black: 5000 pcs.

Application example



Can secure in double loops

Securing optical fiber cables

- Elastomer fastens optical fiber cables safely and securely.
- Supports a wide range of bundle diameters and accommodates adjustment of the number of cables.



Features

- Various application use for bundling wires, cables and hoses (tubes) etc.
- A range of variations are available to meet requirements.

Plenty of the variations are available in addition to the products in this catalog, as well as in other materials and colors.

- Please contact our sales department for details.

Standard type

Material

- Nylon 66 (Color: Natural) **UL94 V-2**

A type



B type

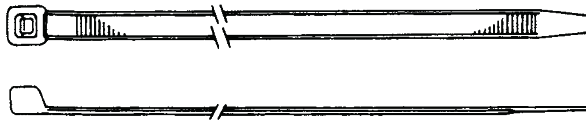

Part No.	Configuration type	Max bundle diameter	Length	Width	N(kg) Tensile strength	Std. Package	
UL SKB-85mm	A	φ 18	85	2.2	68.64 (7)	1,000 pcs.	
UL SKB-80M			80	1.9			
UL SKB-1M		φ 21	145	2.5	117.67 (12)		
UL SKB-1.5M							φ 35
UL SKB-2M		φ 37	200	3.4	196.13 (20)		100 pcs.
UL SKB-2.2M							
UL SKB-2.5M	φ 70	275					
UL SKB-2.8M	B	φ 75	282	2.6	117.67 (12)	1,000 pcs.	
UL SKB-3M			φ 50	185	4.5		294.19 (30)
UL SKB-3.5M		φ 70	250	4.8	411.87 (42)		
UL SKB-4M							5.0
UL SKB-5M		φ 100	365	7.8	539.36 (55)		100 pcs.

UL ...UL1565 recognized product

(Unit: mm)

Open head type

Material

- Nylon 66 (Color: Natural) **UL94 V-2**



Easy operation!
Insert the end of the strip into the open head to bundle.



Part No.	Max bundle diameter	Length	Width	N(kg) Tensile strength	Std. Package
UL SKB-2	φ 32	154	3.4	137.29 (14)	1,000 pcs.
UL SKB-3	φ 44	186	4.0	196.13 (20)	

UL ...UL1565 recognized product

(Unit: mm)

Reusable type



Material

● Nylon 66 (Color: Natural)

UL94 V-2

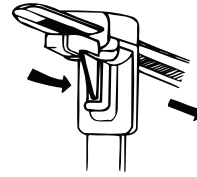
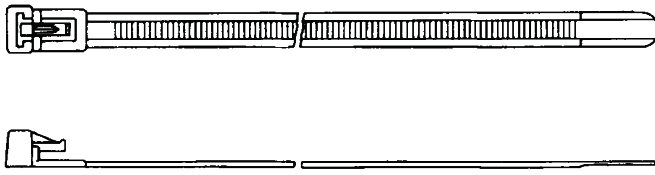

Part No.	Max bundle diameter	Length	Width	N(kg) Tensile strength	Std. Package
UL SF-150R	φ 40	150	6.9	294.19 (30)	3,000 pcs.
RS-145	φ 38	145	7.3	343.22 (35)	1,000 pcs.
RS-250	φ 70	250			

UL ...UL1565 recognized product

(Unit: mm)

Screw mount type

Material

● Nylon 66 (Color: Natural)

UL94 V-2



Part No.	Max bundle diameter	Length	Width	N(kg) Tensile strength	Mounting hole size	Std. Package
UL SKB-145F	φ 32	145	3.5	156.90 (16)	φ 4.5	1,000 pcs.

UL ...UL1565 recognized product

(Unit: mm)

Push mount type

Material

● Nylon 66 (Color: Natural)

UL94 V-2



Part No.	Max bundle diameter	Length	Width	N(kg) Tensile strength	Mounting hole size	Max. panel thickness	Std. Package
UL SKB-145P	φ 32	157	3.5	156.90 (16)	φ 4.8	2.4	1,000 pcs.

UL ...UL1565 recognized product

(Unit: mm)